

3. Footing drain is placed on top of footing.
4. Floor slab is poured level with, rather than on top of footing. Apply DELTA®-COLDJOINT BARRIER membrane or other suitable waterproofing to cover the footing and wall to a point 12" (30 cm) higher than the anticipated water table (see detail 11).

Clean-up and Inspection:

- Walk around foundation and ensure all materials are installed as required.
- Clean up all excess materials and remove from excavation.

Disposal of Waste:

- DELTA®-MS is made out of environmentally friendly HDPE.
- Waste can be recycled where facilities allow.

Limitations:

- DELTA®-MS should not be exposed to ultra violet light (sun light) for more than 30 days.

Note: Other approved installation methods are available at www.delta-ms.com
For technical support, call the Technical Support Team at 1-888-4DELTA4 (1-888-433-5824) ext: 326.

Evaluation Reports (Certifications)

- Dampproofing & Wall Waterproofing Membrane - ICC ES, ESR-2303
- Drainage Layer – CCMC # 12788-R
- Dampproofing – CCMC # 12658-R

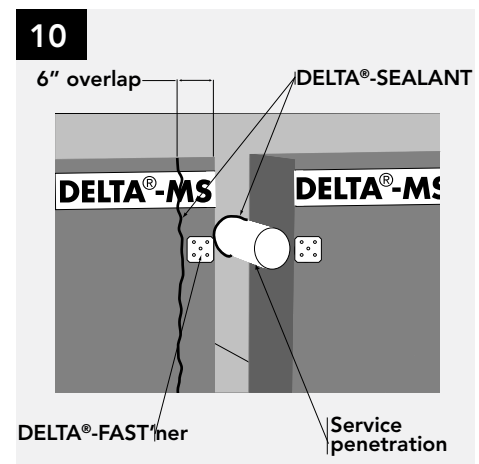
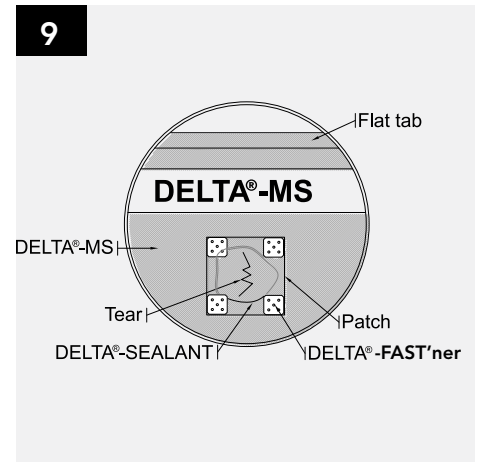

COSELLA DÖRKEN
 Cosella-Dörken Products Inc.
 4655 Delta Way
 Beamsville, Ontario
 L0R 1B4
 (905) 563-3255
 Fax: (905) 563-5582
 1-888-4DELTA4 (433-5824)
 info@cosella-dorcken.com
 www.delta-ms.com

A company of the Dörken Group



DELTA®-branded quality products manufactured by Cosella-Dörken.

The information printed in this manual reflects product information and specifications at the date of printing. The manufacturer reserves the right to make changes when necessary.

DELTA®

DELTA® protects property. Saves energy. Creates comfort.

COSELLA DÖRKEN



DELTA®-MS (Membrane System)

Foundation Dampproofing and Wall Waterproofing Membrane.™

Installation Manual

Method # 1 (using DELTA®-FAST'ners & DELTA®-MOLD STRIP)

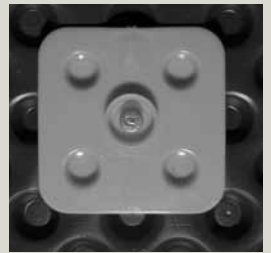

PREMIUM QUALITY

DELTA[®]-MS

Foundation Dampproofing and Wall Waterproofing Membrane.™

Health and Safety:

- Required safety equipment: hard hat, safety boots, gloves, safety glasses.
- Always follow all safety precautions as directed by the Occupational Safety and Health Administration (OSHA-USA) or the Construction Safety Association (Canada).
- There are no health risks in using DELTA[®]-MS and the recommended components.
- Please refer to Material Safety Data Sheets.
- The general codes of practice for protection at work and instructions of the manufacturers for tools and components are to be observed at all times

Recommended Tools:

- Hammer or automated nailing gun (i.e. Trak-Fast 1100 or Hilti GX120).
- Concrete nails 1 ¼" (3 cm) – 1 ½" (3.8 cm).
- Utility knife or tin snips.
- Large caulking gun, chalk line, broom.

Getting Down to Installation:

- Mark a line (i.e. snap a chalk line) 1" (2.5 cm) below expected final grade line as a starting point.
- Clean top of footer of any gravel and debris with broom.
- The "flat tab" and orange stripe of DELTA[®]-MS should always be at the top of the installation and facing the installer (see Detail 1).
- Option 1: Recommended Best Practice
With the flat tab lined up along the chalk line, roll out DELTA[®]-MS continuously with the membrane draping over top of footing. Position the roll in the direction of installation for easy roll-out of the dimpled membrane (see Detail 2, Option 1).
- Option 2:
Place the bottom of the roll on top of the footing with the roll positioned in the direction of installation for easy roll-out of the dimpled membrane (see Detail 2, Option 2).
- Always install DELTA[®]-MS tightly and evenly over the foundation wall.
- For ease of installation, work with 2 people.
- Roll out DELTA[®]-MS approximately 10' (3 m) in length along the wall.
- As one person holds the DELTA[®]-MS, the other person installs the DELTA[®]-FAST'ners in the body at appropriate intervals, as shown in Detail 3.
- For rolls greater than 7' (2 m) in height an extra row of DELTA[®]-FAST'ners is suggested in the middle of the membrane.
- Apply a bead of DELTA[®]-SEALANT behind the flat tab to prevent soil particles from entering the air gap.
- Install DELTA[®]-MOLD STRIP at the flat tab using concrete nails (see Detail 3).

Installing around Corners:

- Install DELTA[®]-MS on inside corners as tightly as possible by pushing the membrane into the corner, then anchor it in place with DELTA[®]-FAST'ners in the body and DELTA[®]-MOLD STRIP on the flat tab (see Detail 4).
- Install DELTA[®]-MS on outside corners as tightly as possible by pressing the membrane around the corner, then anchor it in place with DELTA[®]-FAST'ners in the body and DELTA[®]-MOLD STRIP on the flat tab (see Detail 5).

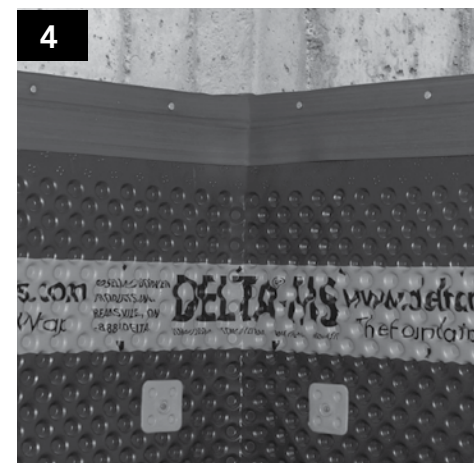
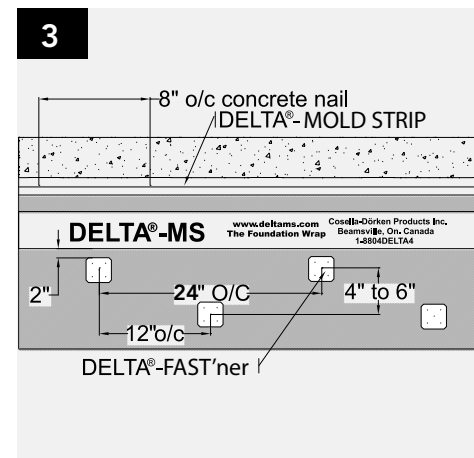
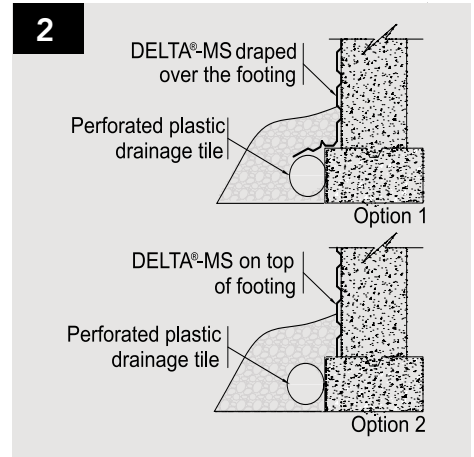
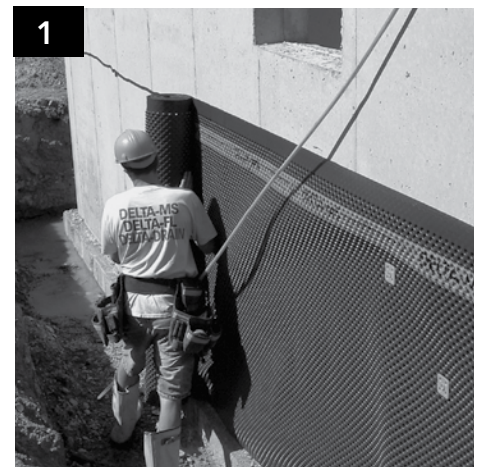

- Do not install DELTA®-FAST'ners within 3" (8 cm) of outside corners to avoid damaging the concrete.

Joints and Overlaps:

- Vertical joints require the installation of DELTA®-FAST'ners along the length of the joint 12" (30 cm) o/c, with minimum 6" (15 cm) overlap (see Detail 6).
- For foundations higher than the roll height, install the first course by rolling out DELTA®-MS at the bottom of the wall. The next course of DELTA®-MS shall overlap the bottom layer by at least 6" (15 cm), shingled downwards.
- Horizontal joints require the installation of DELTA®-FAST'ners along the length of the joints at 3' (0.9 m) o/c. DELTA®-MOLD STRIP is not required on the lower overlapped section (see Detail 7).

Installation of DELTA®- MOLD STRIP:

- Install DELTA®-MOLD STRIP at all below grade cuts of the membrane such as at window wells, walkouts, vertical termination, etc. (see Detail 8).
- Cut back DELTA®-MS 3" (8 cm) from the edge of wall openings.
- Position the wider edge of the DELTA®-MOLD STRIP over DELTA®-MS.
- Use DELTA®-MOLD STRIP at sloped cuts in the DELTA®-MS.
- Anchor DELTA®-MOLD STRIP 8" (20 cm) o/c using 1 1/2" (3.8 cm) or 1 1/4" (3 cm) concrete nails.

Repairs:

- Should DELTA®-MS get damaged prior to backfill, cut patches of DELTA®-MS large enough to cover any tear. Minimum 6" (15 cm) around damaged area.
- Apply a bead of DELTA®-SEALANT around the tear.
- Apply patch over tear and install DELTA®-FAST'ners to hold the patch tightly against membrane making sure dimples align (see Detail 9).

Service Penetrations:

- When encountering a service penetration protruding from the foundation, roll DELTA®-MS flush to penetration.
- Cut the DELTA®-MS vertically. Fasten the cut end with DELTA®-FAST'ners to keep in place 3' (0.9 m) o/c vertically.
- Restart application on other side of service penetration. Unroll enough DELTA®-MS to go around the service penetration plus another 6" (15 cm) for overlap.
- Cut the length of unrolled portion horizontally at a point equal to the center of the service penetration (see Detail 10).
- Pull the slit portion around the penetration and trim the DELTA®-MS to fit snugly.
- Peel back the cut membrane and apply DELTA®-SEALANT around the penetration.
- Push the cut membrane back around the penetration.
- Interlock the overlapping dimples.
- Treat as a standard vertical lap with DELTA®-FAST'ners 12" (30 cm) o/c, being sure to place a DELTA®-FAST'ners on top and bottom of the slit.

Recommended Best Practice (optional):

DELTA®-COLDJOINT BARRIER for moisture protection at cold joint area at the base of the wall.

DELTA®-COLDJOINT BARRIER must be installed prior to installing DELTA®-MS membrane if:

1. A fluctuating water table is encountered.
2. Footing drain is insufficient to take away water drained by DELTA®-MS without temporary backup.

